

Electric Hydraulic Dynamic and Fatigue Testing System

EHF Series

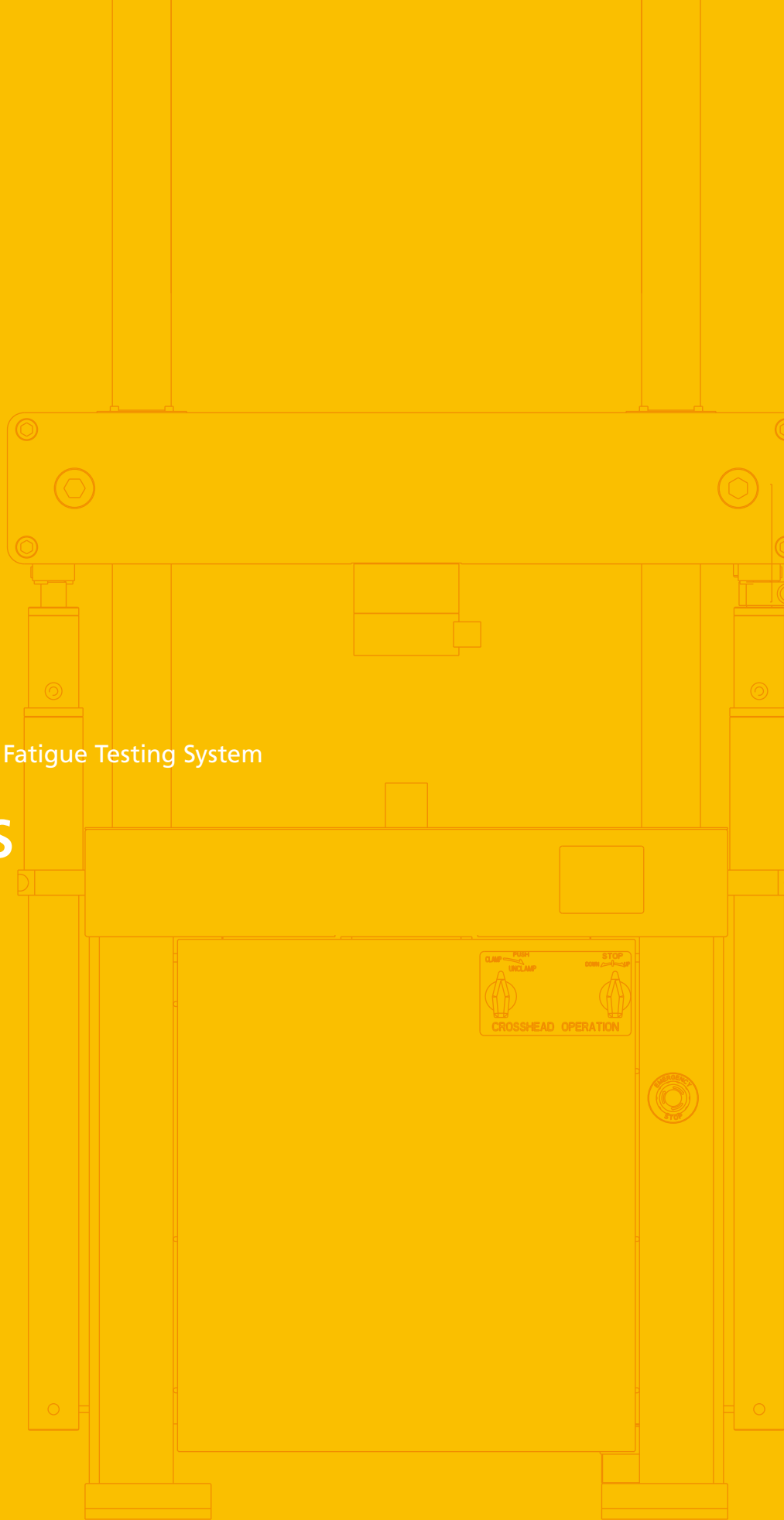

EHF-U Series



For Full-Scale Fatigue and Endurance Testing of Structural Materials and Large Samples

By providing a T-slot surface plate at the bottom of a U-type loading frame with a top-mounted actuator, these systems allow installation of extra large components and parts. Due to the large testing space, dynamic testing and evaluation can be performed on a variety of samples, including full-size samples and structural members.

Rated Actuator Capacities of 50 kN, 100 kN, and 200 kN Support a Wide Range of Dynamic Testing

Top-Mounted Actuator

Supports dynamic and endurance testing of full-size samples, large components, and structural members.

Hydraulically lifting/lowering crosshead

±0.5 % test force accuracy

Test force accuracy is guaranteed to within ±0.5 % of the indicated value.

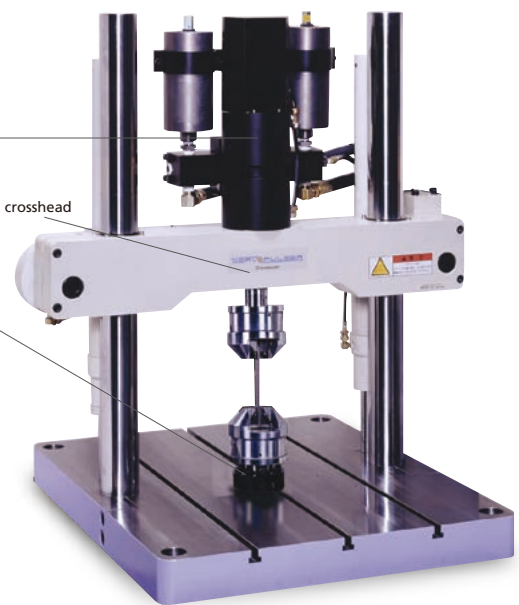

High Rigidity and Large Testing Space

A T-slot surface plate makes it easy to secure samples. The size of the surface plate and length of the columns can be customized based on the size of samples.

High-accuracy column



Crosshead drive handle

Crosshead Drive System with Operating Error Prevention Mechanism

The hydraulic crosshead drive and hydraulic clamp can be operated intuitively using the handle.



Specifications

Model	EHF -UV050k1	EHF -UV050k2	EHF -UV100k1	EHF -UV100k2	EHF -UV200k1	EHF -UV200k2
Max. dynamic test force	±50kN		±100kN		±200kN	
Max. static test force	±60kN		±120kN		±240kN	
Piston stroke	±25mm	±50mm	±25mm	±50mm	±25mm	±50mm
Cycle speed and amplitude	See amplitude characteristics charts.					
Controlled items	Test force and stroke (two can be added as options)					
Test force	Range					
	24-bit rangeless					
Indication accuracy		Within 0.5 % of indicated value or ±0.02 % of maximum dynamic test force, whichever is greater				
Crosshead drive mechanism		Hydraulic drive (with hydraulic clamp)				
Applicable hydraulic power supply unit		QF-10B, QF-20B, QF-40B, QF-70B, QF-110, QF-140 AF-10B, AF-20B				
Power requirements		Varies depending on the hydraulic power supply unit (see pages 34 and 35).				

Testing Machine Main Unit Dimensions

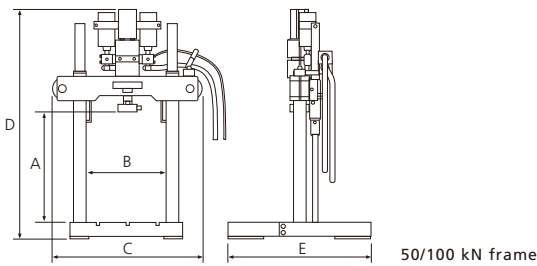

	Capacity	50kN								100kN																							
	Actuator stroke	±25mm				±50mm				±25mm				±50mm																			
	Column length	Standard		Standard + 400		Standard		Standard + 400		Standard		Standard + 400		Standard		Standard + 400																	
Testing space (mm)	A	179 to 789		379 to 1189		154 to 764		354 to 1164		175 to 740		375 to 1140		150 to 715		350 to 1115																	
	B	560																															
	C	1046																															
Main unit dimensions (mm)	D	1610				2010				1710				2110				1655				2055				1755				2155			
	E	1000	1500	2000	1000	1500	2000	1000	1500	2000	1000	1500	2000	1000	1500	2000	1000	1500	2000	1000	1500	2000	1000	1500	2000	1000	1500	2000					
Weight (kg)		970	1330	1630	1000	1360	1660	970	1330	1630	1000	1360	1660	1070	1460	1900	1100	1500	1940	1070	1460	1900	1100	1500	1940								
Frame rigidity (mm/kN)*		0.0025																0.0019															

* Crosshead table clearance: 500 mm

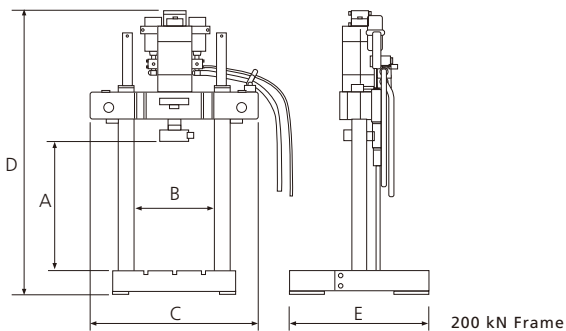

	Capacity	200kN															
	Actuator stroke	±25mm						±50mm									
	Column length	Standard		Standard + 400				Standard		Standard + 400							
Testing space (mm)	A	199 to 954		399 to 1354				174 to 929		374 to 1329							
	B	560															
	C	1200															
Main unit dimensions (mm)	D	2255				2655				2305				2705			
	E	1000	1500	2000	1000	1500	2000	1000	1500	2000	1000	1500	2000	1000	1500	2000	
Weight (kg)		1960	2570	3240	2030	2640	3310	1960	2570	3240	2030	2640	3310				
Frame rigidity (mm/kN)*		0.0009															

* Crosshead table clearance: 500 mm

Amplitude Characteristics (60 Hz)

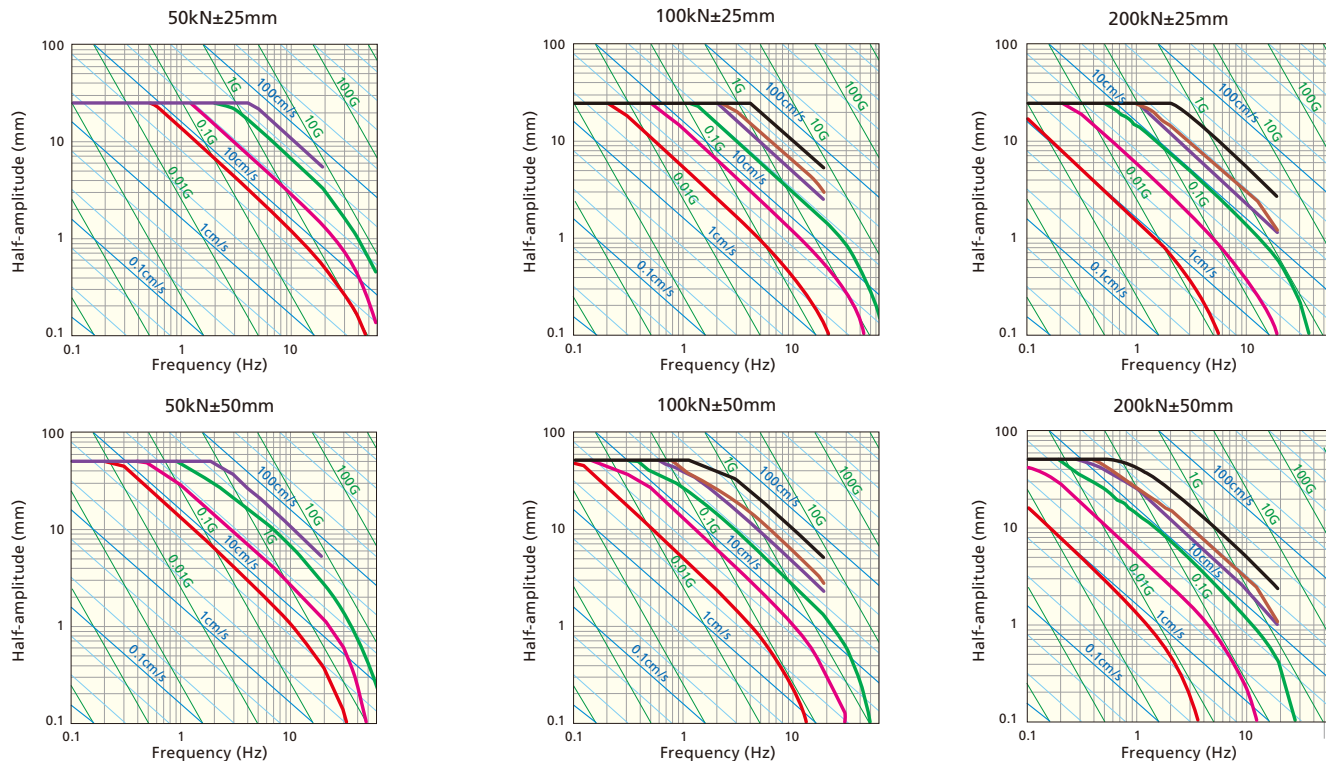
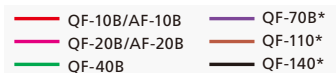

* It is not possible to use standard configurations of models QF-70B or higher for high-frequency regions, due to the servo valve characteristics. However, these models may be used for testing at high frequencies if the servo valve is changed, for example. Contact Shimadzu for more information.

- The above characteristic curves indicate the relation between half-amplitude and cycle speed, given sine wave motion at the rated load level.
- The above indicates the amplitude characteristics given a 60 Hz power supply. Characteristics with a 50 Hz power supply will be about 5/6 of indicated values.
- The above characteristics do not include the frame or load cell characteristics. Compensate for the influence of these factors to determine actual amplitude characteristics.
- The indicated characteristics values were calculated based on typical characteristics of the servo valve being used, which may result in a difference of about 10 % on the frequency axis.
- There may be limitations on testing frequencies, depending on jig, sample, or other characteristics.

Standard Layout

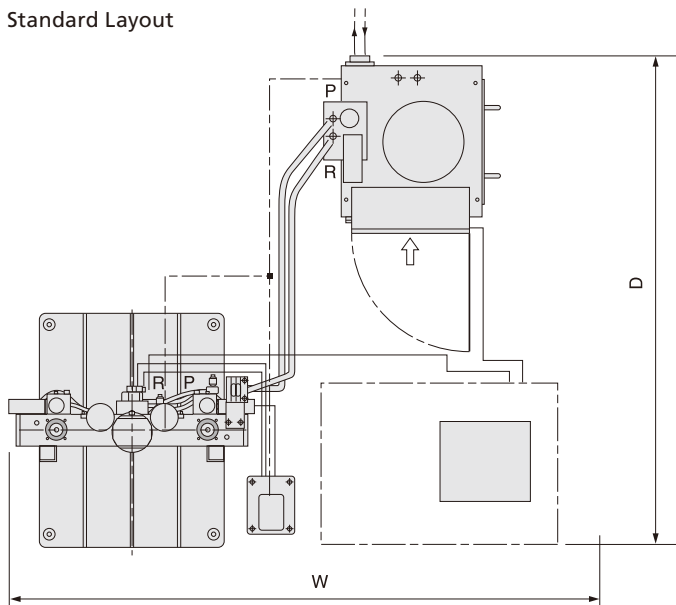

Main Unit	Hydraulic Power Supply Unit	Space Required (W x D)
U50kN	QF-10B	2500×2100
	QF-20B	2500×2200
	QF-40B	2500×2600
	QF-70B	2500×2800
	AF-10B	2500×2200
	AF-20B	2500×2200
U100kN	QF-10B	2500×2100
	QF-20B	2500×2200
	QF-40B	2500×2600
	QF-70B	2500×2800
	AF-10B	2500×2200
	AF-20B	2500×2200
U200kN	QF-10B	2600×2100
	QF-20B	2600×2200
	QF-40B	2600×2600
	QF-70B	2600×2800
	AF-10B	2600×2200
	AF-20B	2600×2200

- At the installation site, provide about 500 mm of space on all four sides of the system, in addition to the space requirements indicated above, to allow access for operation and maintenance.
- The drawing above indicates the dedicated space requirements. The shape and orientation of the hydraulic power supply unit may vary depending on its capacity.
- For a more detailed standard layout drawing, contact Shimadzu.
- The standard system configuration does not include the table, computer, or printer.

Optional Accessories and Systems

Servopulser series systems allow selection of the optimal combination of units based on testing objectives. In addition, an extensive selection of optional testing equipment, such as various testing jigs, detectors, and atmospheric control testing units, is available. For more details, refer to the separate optional accessories brochure.

Tensile and Compression Test Jigs

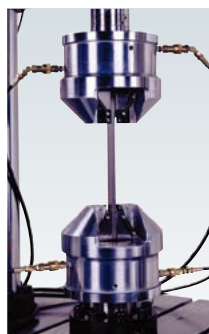

● Front-Opening Hydraulic Grip

Designed for full-amplitude tensile and compression fatigue testing, these grips offer superior ease-of-operation and ensure high-accuracy testing for a wide range of tests.

Maximum test force	±20 to 200 kN (multiple capacities available)
Operating temperature range	RT to +50 °C
Applicable sample	Rod / flat plate

Metals Plastics Composite materials

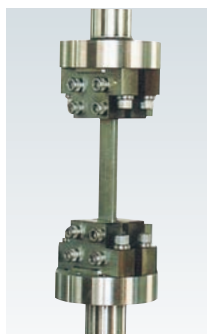

● Manual Non-Shift Plate Grip

These grips are designed for full-amplitude tensile and compression fatigue testing of flat plate materials and feature a simple and efficient construction.

Maximum test force	±5 to 100 kN (multiple capacities available)
Operating temperature range	RT to +50 °C -196 to +300 °C
Applicable sample	Flat plate

Metals Plastics Composite materials

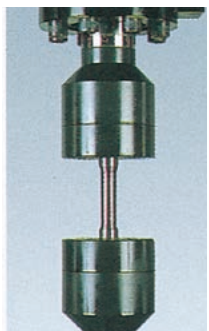

● Split Flange Rod Grip

These grips allow samples to be secured easily and firmly. They are ideal for full-amplitude tensile and compression fatigue testing of round rod samples.

Maximum test force	±10 to 200 kN (multiple capacities available)
Operating temperature range	RT to +100 °C -196 to 300 °C
Applicable sample	Rod

Metals Plastics Composite materials



● Pin-Type Grip for Flat Samples + Dynamic Strain Gauge (for gauge length displacement)

These grips are designed for half-amplitude tensile fatigue testing.

Note: Supports only tensile testing.

Maximum test force	+6 kN/10 kN
Operating temperature range	-196 to +300 °C (±6 kN) -20 to +300 °C (±10 kN)
Applicable sample	Flat plate (max. 30 mm wide and 5 mm thick)

Metals Composite materials Lumber Plastics



● Non-Shift Wedge Grip for Static Testing

These grips can only be used for static testing. These high-capacity grips apply the self-tightening action of a wedge.

Note: Supports only tensile testing.

Maximum test force	±20 to 250 kN (multiple capacities available)
Operating temperature range	0 to +120 °C
Applicable sample	Rod / flat plate

Metals Composite materials Lumber Plastics



● Grips for CT Test Samples + Clip Gauge

These compact grips are designed specifically for tensile test samples and are compliant with ASTM E399 and E1820 standards. They can be used for tests performed to determine fracture toughness or crack propagation.

Note: Supports only tensile testing.

Maximum test force	±6 to 80 kN
Operating temperature range	RT to +100 °C -20 to 300 °C
Applicable sample	CT test sample

Metals Plastics Composite materials

Bolt Testing Jigs



● Screw Tensile Test Jig

This jig is for tensile fatigue testing of various nuts and bolts. Various grips sizes are available depending on the bolt size.

Maximum test force	±100/250 kN
Operating temperature range	RT to +50 °C
Applicable sample	Nuts/bolts

Metals Plastics Composite materials



● Screw Looseness Test Device

This device allows testing various parameters to determine the loosening process of bolts. It applies a vibrational displacement in the thread tightening direction and in the perpendicular direction and then measures the change in tightening force in relation to the number of vibrations.

Maximum test force	±20 kN
Operating temperature range	RT to +100 °C -20 to +300 °C
Applicable sample	CT test sample

Metals Plastics Composite materials

Compression and Bending Test Jigs



● Compression Plate

Compression plates are available with both the top and bottom fixed or with the top compression plate mounted on a spherical seat.

Maximum test force	20 to 500 kN (multiple capacities available)
Operating temperature range	RT to +250 °C
Applicable sample	60 to 220 mm dia.

- Metals
- Plastics
- Composite materials
- Rubber
- Rock
- Component



● 3-Point/4-Point Bending Test Jig (for partial half-amplitude fatigue testing)

Maximum test force	2kN
Max. dynamic bending moment	50 N/m
Operating temperature range	RT to +100 °C -196 to +300 °C
Jig dimensions	Lower span: 30 to 100 mm Upper span: 15 to 50 mm

- Metals
- Plastics
- Composite materials



● Uniform Bending Test Jig (for full-amplitude fatigue testing)

This jig uses ball bearings at each support point to apply uniform bending loads.

Maximum test force	±2 to 10 kN
Max. dynamic bending moment	±20 to 250 N/m
Operating temperature range	RT to +50 °C -196 to +200 °C

- Metals
- Plastics
- Composite materials



● CTOD Bending Test Jig + Clip Gauge

This jig is for CTOD bending tests compliant with ASTM E339. It is used for fracture toughness testing.

Maximum test force	50/100 kN
Max. dynamic bending moment	2/6 k N/m
Operating temperature range	RT to +100 °C -196 to +300 °C

- Metals
- Plastics
- Composite materials

Axis Adjustment System

Consisting of an axis adjustment unit, axis center sensor testing sample, strain amplifier unit, and dedicated axis adjustment software, this system allows adjusting the tilt between grips and adjusting the axis centers in the horizontal direction. It allows users to obtain highly reliable data by eliminating any bending stresses on samples.

- Metals
- Plastics
- Composite materials

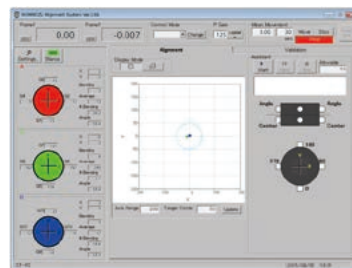

Various Environmental Control Testing Systems

Various environmental control testing systems are required to simulate harsh environments or environments where materials are actually used, such as thermostatic, high-temperature, or extremely low-temperature environments. Therefore, an environmental control system can be added in the large testing space provided by the Servopulser series system.

See page 58.

- Metals



Water-Cooled Hydraulic Power Supply Unit

QF Series

These hydraulic power supply units are designed specifically for electric-hydraulic dynamic and fatigue testing systems. The system includes an oil pump, oil tank, filter, cooler, pressure regulator, and other equipment.



- The oil pump is a gear pump with minimal pulsing and low noise.
- The filter includes a 3-micron element that helps prevent wear in the servo valve and other equipment.
- Space savings have been achieved by orienting the pump and motor vertically (QF-10B to 70B, AF-4, and AF-10B to 20B).

Model		QF-10B	QF-20B	QF-40B	QF-70B	QF-110*	QF-140
Applicable testing system	E-type	○	○	○	○	○	○
	U-type	○	○	○	○	○	○
	L-type	○	○	○	○	○	○
	JF-type	○	○	○	○	○	○
	J-type	○	○	○	○	○	○
	T-type	○	○	○	○	○	○
Output (approx.)	50Hz	9L/min	19L/min	42L/min	81L/min	108L/min	138L/min
	60Hz	11L/min	24L/min	51L/min	11L/min	104L/min	162L/min
Oil pressure	Normal	21MPa					
Hydraulic oil		Mobil DTE 25					
Pump	Type	Fixed output gear pump					
	Number of units	1			2		
Motor	Capacity	5.5kw	11kw	22kw	37kw	45kw	37kwx2
Oil filter		3µm					
Tank capacity		90L	90L	190L	300L	500L	590L
Operating noise (at 21 MPa)		74dBA	76dBA	78dBA	80dBA	83dBA	85dBA
Power requirements	Single-phase 100 V	1.5kVA					
	Three-phase 200 V	8kVA	16kVA	32kVA	47kVA	57kVA	93kVA
Cooling water volume required		20L/min	20L/min	65L/min	80L/min	110L/min	150/180L/min(050Hz/60Hz)
Compatible cooling tower (tons of cooling)		2	3	5	10	20	20
Main unit dimensions (approx.)	Width (mm)	830mm	920mm	1100mm	1200mm	1730mm	1950mm
	Depth	750mm	750mm	860mm	1000mm	1290mm	1500mm
	Height	1235mm	1235mm	1400mm	1515mm	1370mm	1550mm
Weight	Including oil	Approx. 530 kg	Approx. 530 kg	Approx. 720 kg	Approx. 920 kg	Approx. 1500 kg	Approx. 2200 kg
Recommended circuit breaker capacity (3-phase 200 V / 1-phase 100 V)		50A/15A	100A/15A	150A/15A	200A/15A	300A/15A	400A/15A

Notes

- The indicated operating noise values are provided for reference and are not guaranteed.
- The operating noise level may vary depending on the installation site conditions.
- * 50 Hz and 60 Hz models are available for the QF-110 only.

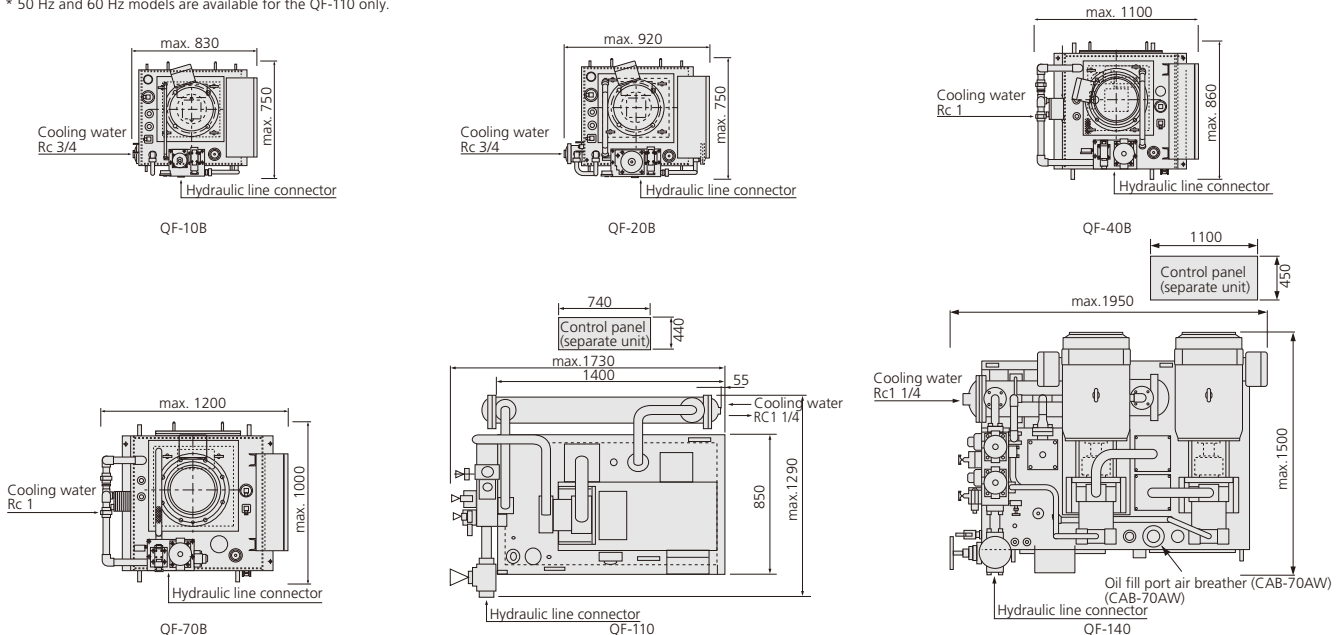

Air-Cooled Hydraulic Power Supply Unit

AF Series

These hydraulic power supply units are designed specifically for electric-hydraulic dynamic and fatigue testing systems. The system includes an oil pump, oil tank, filter, cooler, pressure regulator, and other equipment.

- The oil pump is a gear pump with minimal pulsing and low noise.
- Does not need any cooling water.



AF-4-type

Model		AF-4	AF-10B	AF-20B
Applicable testing system	E-type		○	○
	U-type		○	○
	L-type	○	○	○
	JF-type		○	○
	J-type		○	○
	T-type		○	○
	TQJ-type		○	○
Output (approx.)	50Hz	3.7L/min	9L/min	19L/min
	60Hz	4.5L/min	11L/min	24L/min
Oil Pressure	Normal	21MPa		
Hydraulic oil		Mobil DTE 25		
Pump	Type	Fixed output gear pump		
	Number of units	1		
Motor	Capacity	2.2kw	5.5kw	11kw
Cooling fan		0.1kw	0.1kw	0.2kw
Oil filter		3μm		
Tank capacity		24L	90L	90L
Operating noise*		56dBA	64dBA	71dBA
Power Supply	Single-phase 100 V	1.5kVA		
	Three-phase 200 V	3.5kVA	8kVA	17kVA
Dimensions	Width (mm)	800mm	870mm	870mm
	Depth	770mm	900mm	900mm
	Height	700mm	1700mm	1700mm
Weight	Including oil	Approx. 185 kg	Approx. 630 kg	Approx. 630 kg
Recommended circuit breaker capacity (3-phase 200 V / 1-phase 100 V)		20A/15A	50A/15A	100A/15A

* The AF-4 operating noise value indicates the level in front of the unit when it is installed in the dedicated base stand.

Note: The AF series is air-cooled. Keep the ambient temperature at the hydraulic power supply unit installation site at 25 °C or less.

* The indicated operating noise values are provided for reference and are not guaranteed.

* The operating noise level may vary depending on the installation site conditions.

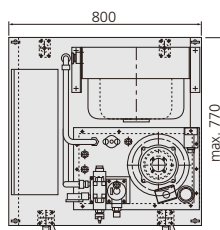

AF-4

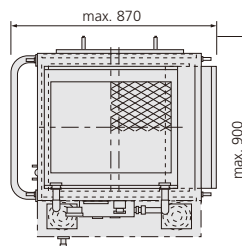

AF-10B

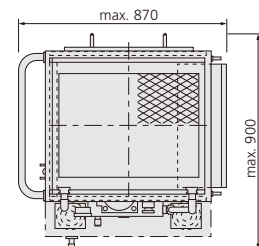

AF-20B

Energy-Conservation Unit for Servopulser Series Hydraulic Power Supply Units

ECU Series

Helps Reduce Energy Consumption, CO2 Emissions, and Running Costs by Up to 50 %

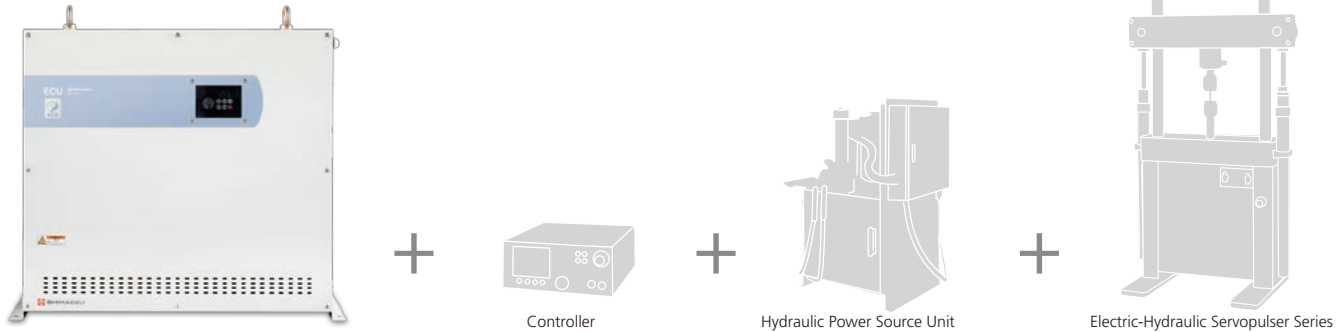

Up to 50 % Lower Power Consumption

Automatic Energy-Saving Operation

Remote Operation



ECU Controller

Lower Running Costs

Using the ECU energy-conservation unit enables an energy-saving mode that can switch OFF the hydraulic power supply unit power depending on the testing parameters and testing status. It also reduces the hydraulic power supply unit's power level when tests are in standby mode.

Note: When using the ECU2 in a region with 60 Hz power supply (up to 30 % when using the ECU1).

Automatically Sets the Optimal Energy-Saving Mode

Used in combination with Microsoft Windows software, the ECU unit can automatically set the optimal energy-saving mode based on test parameters or testing status. This efficiently reduces operating power consumption while continuing to perform intended tests.

Operation with a Hand-Held Controller

The unit can be operated with a hand-held controller.

The hydraulic power supply unit's energy-saving settings (motor frequency and supply pressure settings) can be set from the Servo Controller 4830 or from Windows software for 4830.

Lower Hydraulic Power Supply Unit Operating Noise and Heat Generation

The energy-saving mode reduces the operating noise and heat generated from the hydraulic power supply unit. It also reduces heat generated from the oil, which helps extend the life of the oil.

ECU Units Can Be Retrofitted on Existing Hydraulic Power Supply Units (QF-A, QF-B, and AF Series)

Notes

- For systems using a controller model prior to the Servo Controller 4830, an ECU controller is required.
- Retrofitting an ECU unit on an existing system requires an on-site survey of the system in advance.
- It may not be possible to retrofit an ECU unit on existing hydraulic power supply units in poor site conditions.

Energy-Saving Mode Reduces Power Consumption

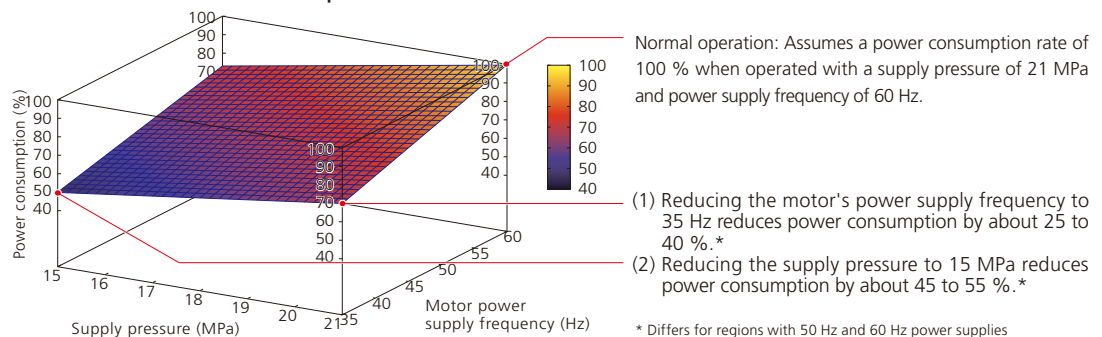

Energy-Saving Operation

Automatic Motor Power Supply Frequency and Supply Pressure Setting (with ECU2 and Windows software)

Automatically operates the system in energy-saving mode when the testing machine is in standby mode or depending on the test load status.

Note: Set manually via the Servo Controller 4830 if Windows software is not available.

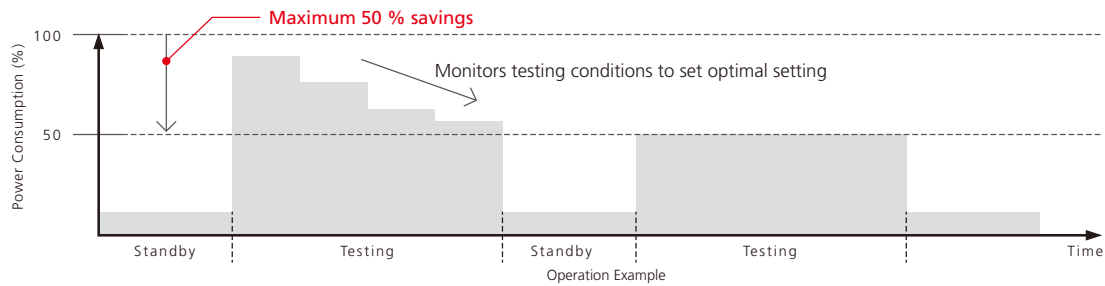

	Motor power supply frequency	Supply pressure
During standby	35Hz	7-9MPa
Just before testing	Automatically settings according to test conditions	
During testing	Periodically checks the displacement amplitude or test force to automatically set appropriate rpm or supply pressure.	

Note: If the function to automatically set the motor power supply frequency and supply pressure is used, the test conditions cannot be changed during testing.

Configuration of Energy-Conservation Unit

ECU1 : Controls the motor's power supply frequency only (contains item (1))

ECU2 : Controls both the motor's power supply frequency and supply pressure (contains items (1) and (2))

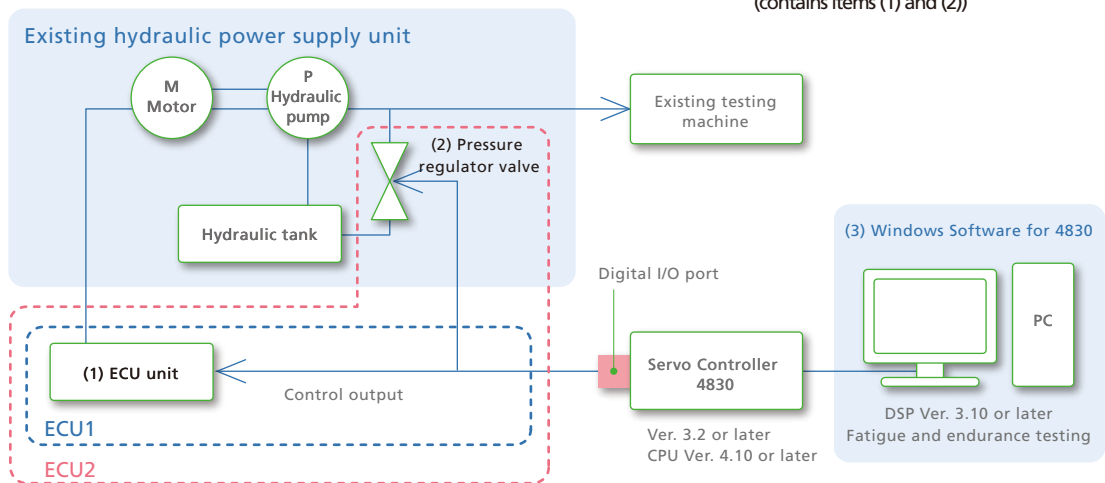

Layout Example

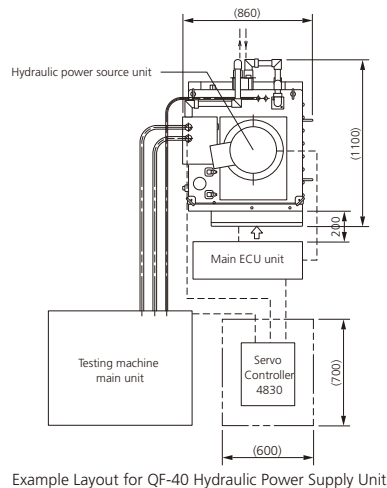

Example Layout for QF-40 Hydraulic Power Supply Unit

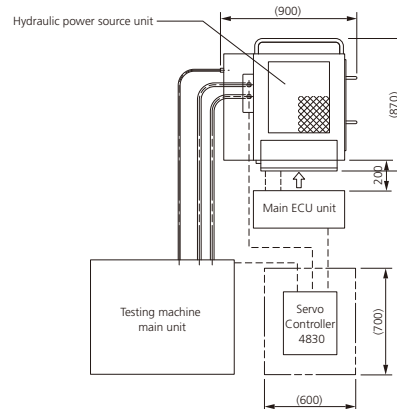

Example Layout for AF-20 Hydraulic Power Supply Unit

Units: mm

EHF-E/U/L Series Electric-Hydraulic Dynamic and Fatigue Testing System Model Code

Electric-hydraulic Servopulser series systems can accommodate a wide variety of test force and testing speed requirements by selecting a combination of the following:

- Loading frame
- Actuator
- Controller and software
- Hydraulic power supply unit

EHF-E/U/L Series Electric-Hydraulic Dynamic and Fatigue Testing System Model Code

EHF - U V 0 5 0 k 1 - 0 2 0 - 0 A

1
2
3
4
5
6
7
8

1 Select the loading frame.

Select the best-suited loading frame from the following three options.

<p>L L-Type Loading Frame</p> <p>Tabletop frame with top-mounted actuator</p> <p>Suitable for testing actual and prepared samples at test forces up to 20 kN. Application example: Bearing parts</p>	<p>E E-Type Loading Frame</p> <p>Standard frame with bottom-mounted actuator</p> <p>Suitable for testing small actual and prepared samples at test forces up to 200 kN. Application example: Standard shape samples</p>	<p>U U-Type Loading Frame</p> <p>Standard frame with top-mounted actuator</p> <p>Suitable for testing structural materials and large full-size samples at test forces up to 200 kN. Application example: Large parts</p>
---	--	---

2 Select the controller.

V

Servo Controller 4830

This controller is capable of generating an extensive selection of test waveforms and provides a measurement, control, and waveform display. Optional software allows testing with a combination of waveforms or a simulation of actual waveforms experienced during operation.

3 Select the actuator capacity. (Select a capacity that matches the loading frame capacity.)

Select one of the following maximum test force capacities. Note: For EHF-E series models with 10 to 100 kN capacity, the third digit is a "1."

005 : 5kN
 010 : 10kN
 020 : 20kN
 050 : 50kN
 100 : 100kN
 200 : 200kN

4 Select the stroke length.

Select one of the following actuator stroke lengths (range of motion).

1 : ±25mm
 2 : ±50mm

5 Select the hydraulic power supply unit's flow rate (testing range required).

Select a flow rate referring to the amplitude characteristic curves on pages 26 and 27.

010 : QF-10B
 020 : QF-20B
 040 : QF-40B
 070 : QF-70B
 11E*) : QF-110(50Hz用)
 11W*) : QF-110(60Hz用)

140 : QF-140
 A04 : AF-4
 A10 : AF-10B
 A20 : AF-20B

* Only for the QF-110, the model number differs depending on the frequency.

6 Select loading frame extensions.

Specify whether extended columns (E and U types) or an extended table length (U type) are required, based on the frame dimensions indicated on pages 14 and 15. (The L type is only available in the standard size.)

0 : Standard
 1 : Columns extended by 400 mm
 2 : Standard columns with table extended by 500 mm
 3 : Columns extended by 400 mm and table extended by 500 mm
 4 : Standard columns with table extended by +1000 mm
 5 : Columns extended by 400 mm and table extended by +1000 mm

- Extended columns (E and U types): Standard or +400 mm (2 types) Note: Using a thermostatic chamber requires columns extended by 400 mm.
- Extended table length (U type only): Standard, +500 mm, or +1000 mm (3 types) The table length (depth) can be changed to accommodate the size of samples being tested.

7 Select the layout.

Select a suitable layout from those on pages 28 and 29. To configure a non-standard layout, consult your Shimadzu representative.

A : Standard layout
 Z : Non-standard layout

8 Select optional items.

Indicate whether or not any of the following customization options is required.

U : Includes base stand
 S : Special specifications (consult your Shimadzu representative separately)

Notes:

- Hydraulic drive and clamping mechanism (E and U types only): If the standard hydraulic drive and clamping mechanism are not necessary, due to a fixed testing space, for example.
- Optional base stand (U50 kN and U100 kN only): Allows the system to be elevated about 700 mm higher than when the table is placed on the floor. This option is required when attaching a thermostatic chamber to a U-type loading frame.

Controller for Dynamic and Fatigue Testing Systems

Servo Controller 4830

Controller for Dynamic and Fatigue Testing Systems Servo Controller 4830

Dramatically Improves Accuracy in Evaluating Endurance and Dynamic Strength of Samples Ranging From Materials to Actual Samples

This controller is designed specifically for dynamic testing machines based on Shimadzu's long history of supplying dynamic and fatigue testing systems and based on feedback from many of our customers. It boasts high performance and exceptionally user-friendly operability. Equipped with a 24-bit high-resolution analog-digital converter, and featuring excellent reproducibility of load waveforms due to fully digital control, it can accommodate a wide variety of dynamic testing requirements.



Connectivity to the Entire Family of Shimadzu Dynamic and Fatigue Testing Machines and Non-Shimadzu Hydraulic Testing Machines

Note: Excludes HITS series and USF-2000 models.

The controller can be connected to Servopulser series electric-hydraulic, electromagnetic force, and pneumatic testing systems, jack systems (actuators), and various other testing machines.

It also can be used to update older Shimadzu systems, or controllers for non-Shimadzu hydraulic testing machines.

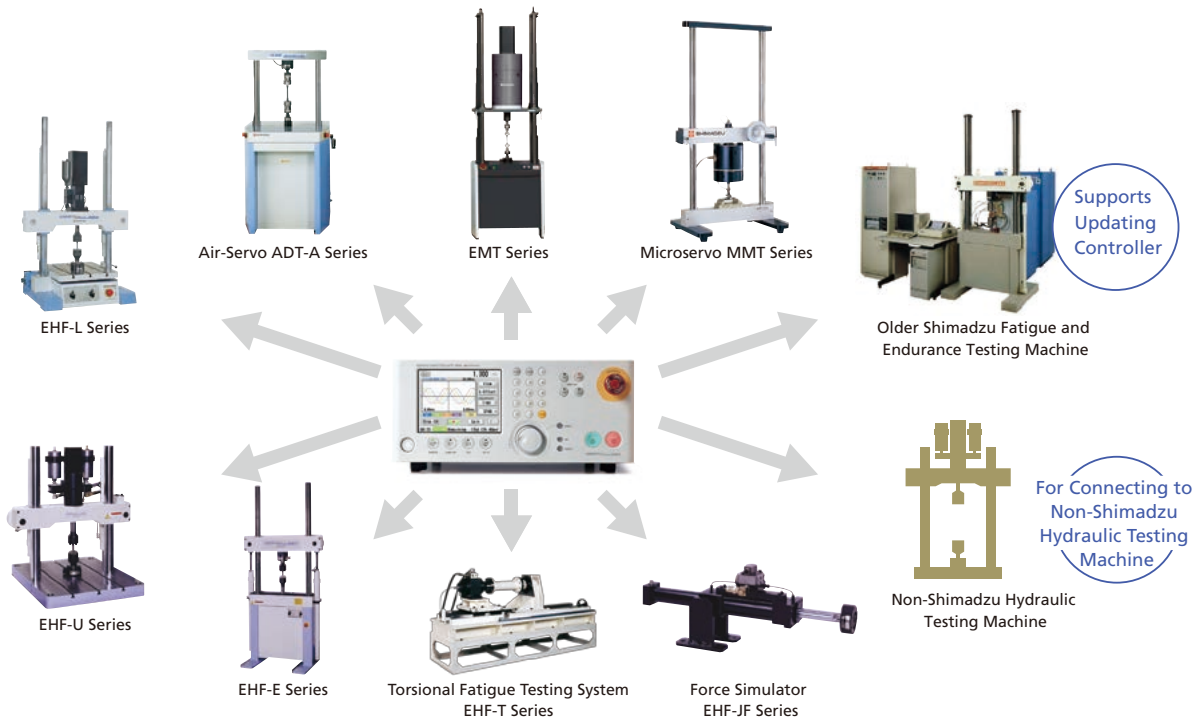



Very Easy to Operate

Testing parameters can be specified using the touch panel or jog dial. Test parameter settings, such as test force and displacement, can be changed at any time during tests.

Color Touch Panel

Enables all parameters to be specified and the test status to be monitored.

Jog Dial

Allows use of an analog type interface to make subtle operating adjustments.

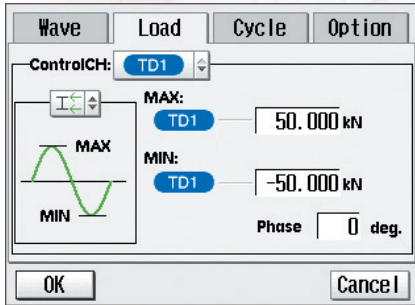

Loading Parameter Settings

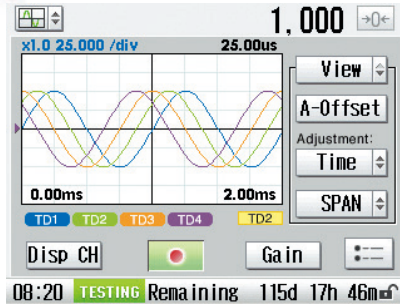

Waveform Display Functions

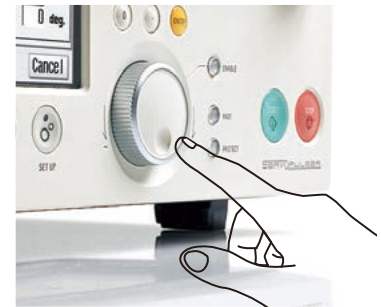

Jog Dial

Autotuning and Automatic Gain Control Functions Ensure Loading Waveforms are Input Precisely

The autotuning function automatically determines the optimal parameters for controlling tests based on the actual test status and sample material. The automatic gain control function makes corrections so that peak values in loading cycles are consistent with parameter settings. Together, these functions help ensure precise loading waveforms. Consequently, even operators performing tests for the first time can automatically achieve highly accurate testing by simply setting parameters and starting testing.

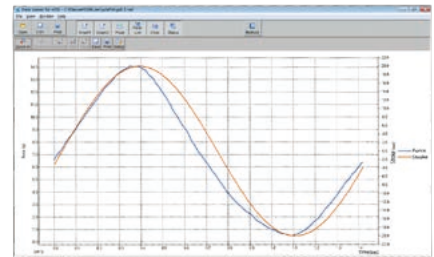

Offset Load Tests

Offset load testing makes it possible to accurately apply offset micro loads while applying large test force loads.

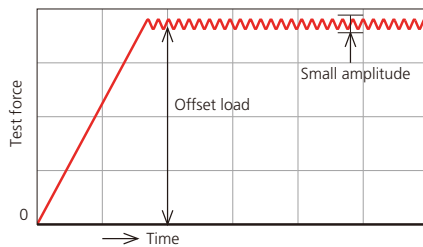

Slow Start/Stop

A slow start/stop time setting can be specified for tests. This eliminates operating differences between operators and helps ensure highly reproducible tests.

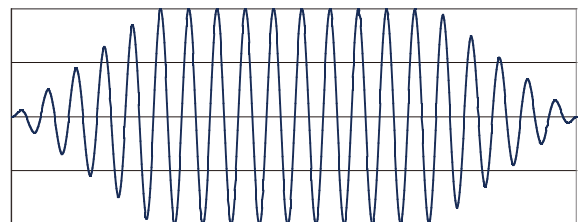

Push Test Function

This allows controlling peak test force values in a stable manner, even for samples with "play" (where no test force is applied).

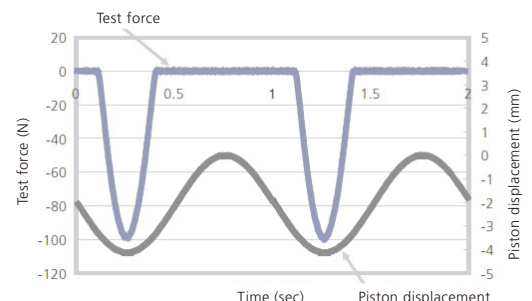
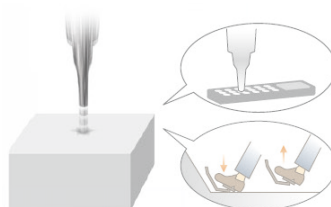

1 Hz Displacement Control with Target Test Force of -100 N

Waveform Distortion Correction Function

Because it can correct for loading mechanism-specific periodic strain, it can cancel out unwanted strain components and accurately control loads according to the target waveform.

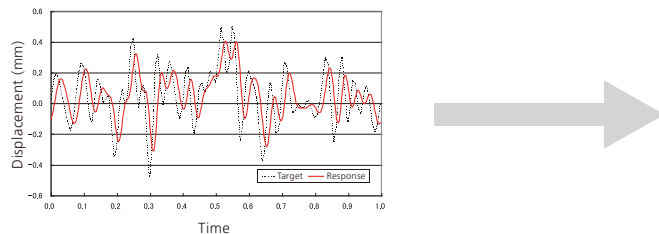

The loading waveform is tracked to ensure consistency with the target waveform.

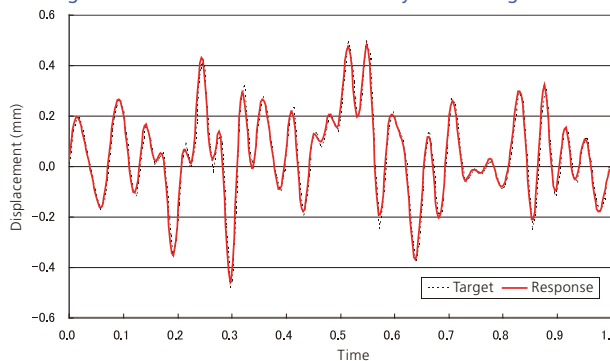

Broad Applicability

Up to four testing machines can be operated for synchronous testing. X-T, X-Y, peak graphs, and a variety of other waveforms can be displayed. By connecting to a computer via a USB cable, a wide variety of test settings and sophisticated data acquisition settings can be specified.

Multiple Tests

A single computer can be used to simultaneously perform up to four different tests using different test parameters. For example, four endurance tests can be performed in parallel to acquire peak values and cycle data.

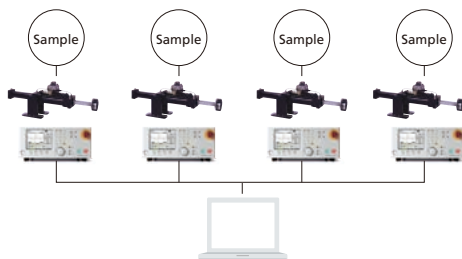

Synchronized Testing

Control and measurements of up to four testing machines can be synchronized by synchronizing the controller connection. The phase can also be freely set for each actuator.

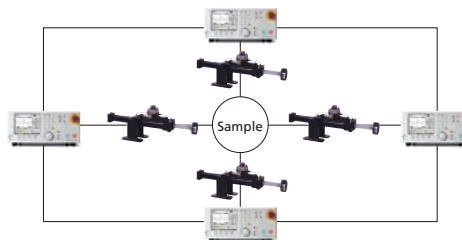

Specifications

Model	Servo Controller 4830
Display unit	5.7-inch color LCD
Control panel	Touch panel, function keys, jog dial, numeric keypad, test operation keys, power unit operation keys
Test waveforms	Sine, triangular, rectangular, haversine, haver-triangular, trapezoidal, ramp, 1/2 haversine, step, sweep, and random waves, external input, programmed waves (optional*), file waves (optional*)
Test frequency	0.00001 to 1000 Hz
Slow settings	Slow start/stop
Test parameter registration	Max. 9 parameters
Waveform display functions	Time, X-Y, and peak waveforms
Measurement functions	1 range (rangeless) 24-bit Max. 40 kHz sampling with 4 acquisition channels Linear correction (linearization) function
Size	W350 x D420 x H148 mm
Control method	Full digital two-degree-of-freedom PID
Control functions	Amplitude, average gain correction (AGC), PID autotuning, sample anti-overloading function (contact load), user-specified phase differential control by synchronized operation, waveform distortion correction*1(transfer function correction)
Limit functions	Measurement value 4-point limiter, cycle counter, external input
Communications functions	USB interface
Other functions	Calculation function (such as adding, subtracting, averaging, and stress/strain), push testing function, consumable consumption time management function
External input/output	Analog Output: 4 channels (± 10 V), Input: 1 channel (± 10 V) For monitoring or waveform input Digital Output: 8 channels Input: 8 channels
Control signal input	Test force (TD1), stroke (TD2), and external input (AUX) Note: Up to two amplifiers can be added as an option.
Power requirements	Single-phase AC 100 to 230 V*2 50/60 Hz 300 VA

*1 Only during software use

*2 The standard power cord included with the system is only for AC 100 V.

Also Supports Updating Controller

Updating older controllers to the latest model improves control performance and enables using the most up-to-date software.



Software for 4830

Easier, More Convenient, and More Sophisticated

Using systems in combination with dedicated software opens up a new world of testing. The dedicated software for the Servo Controller 4830 consists of basic software, add-on testing software, and GLUON 4830 fracture toughness testing software, which collectively support a variety of control and data analysis applications, such as basic fatigue testing, loading tests with simulated actual loads, and physical properties testing compliant with the latest standards.

Software		Single test	Multiple tests (simultaneous testing with 2 to 4 actuators)	Synchronized tests (measurement tests with synchronized control of up to 4 actuators)		
				2	3	4
Basic Software	Fatigue and Endurance Testing	⊙	⊙	○	○	○
	Program Function Testing	⊙	⊙	○	○	○
	Static Characteristics Testing	⊙	⊙	—	—	—
	Combination Testing	⊙	⊙	—	—	—
Add-On Software Note: Requires basic software	Static Testing	⊙	—	—	—	—
	Frequency-Sweep Testing	⊙	—	○	—	—
	Resonance Frequency Tracking Testing	⊙	—	○	—	—
	Multi-Axis Combination Sine Wave Testing (without waveform distortion correction)	⊙	—	○	○	○
	Multi-Axis Combination Sine Wave Testing (with waveform distortion correction)	⊙	—	☆	☆	○
Multi-Axis Working Waveform Simulation Testing	⊙	—	☆	☆	○	
GLUON 4830	Crack Propagation Testing Software	⊙	—	—	—	—
	KIC/COD Testing Software	⊙	—	—	—	—
	JIC Testing Software	⊙	—	—	—	—

⊙ : Compatible ○ : Does not consider response results from other controllers (cannot be used if mutual interference is strong)
 ☆ : Considers response results from other controllers (mutual interference correction)
 — : Not compatible

Menu bar allows test operations such as starting and stopping, changing controls or resetting limits, etc.

Pause test Immediate waveform data acquisition button Dynamic characteristic values can be calculated for each cycle

Testing machine status display
Test in progress / stopped

Real-time measurement value display
Color-coded control parameters

Cycle count vs. control parameter graph makes it possible to check reproducibility of test peaks

Plots S-S curves

Allows checking of waveforms in real time
Allows loading of waveform data from 1000 cycles

Test parameter confirmation window

Fatigue and Endurance Testing Window in Basic Software

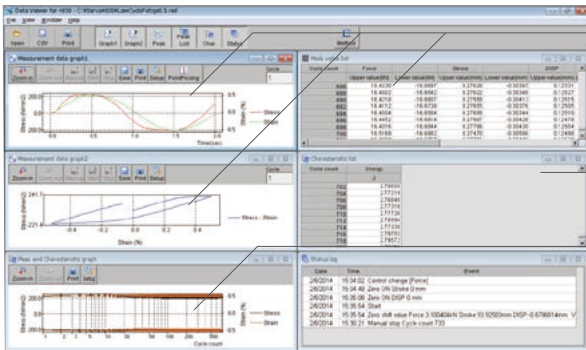

It is possible to confirm the input waveform, stress-strain curve, and various parameters for each acquisition cycle. Data for any specific point can also be extracted from any cycle waveform using the point picking function.

Dynamic characteristic values can be confirmed from each data acquisition cycle.

Peak value graph

S-N curves can be plotted automatically from test results.

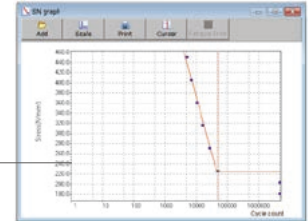

● Basic Software



Fatigue and Endurance Testing

During fatigue/endurance tests, dynamic characteristics can be calculated, which allows S-N curves plotting. Data can be acquired for up to 10,000 cycles (during interval acquisition).



Combination Testing

Combining fatigue/endurance and static characteristics tests makes it possible to measure the changes in static spring constants.



Static Characteristics Testing

This allows users to apply static loads, such as tension or compression, to samples and measuring the static characteristic values (such as the static spring constant).



Program Function Testing

This allows users to combine the loading waveforms available in the controller, such as ramp and sine waves.

● Static Software



Static Testing

Available static tests include tensile, compression, 3-point bending, and 4-point bending. Various characteristic values can be calculated automatically. These include elasticity, upper yield point, lower yield point, yield strength, intermediate test force, intermediate displacement, maximum test force, break point, or energy.

● Frequency-Sweep and Resonance Frequency Tracking Test Software



Frequency-Sweep Testing

Makes it possible to sweep across to test dynamic characteristics over a range of frequencies, and allows endurance testing that repeats sweep cycles. Dynamic characteristic values can also be calculated for each frequency.



Resonance Frequency Tracking Testing

This makes it possible to automatically detect the resonance frequency of test samples before applying loads. The frequency can be automatically tracked if it is changed due to sample fatigue. Acceleration and strain values can be set directly and automatically readjusted even during testing.

● Multi-Axis Combination Sine Wave Testing Software



Multi-Axis Combination Sine Wave Testing

This allows use of multiple axes to perform tests with a combination of sine waves with different amplitudes.

● Multi-Axis Actual Waveform Testing Software



Multi-Axis Working Waveform Simulation Testing

This allows users to load actual working waveform data in CSV format, and to perform sophisticated simulation tests of actual loads by simply starting the test. A strain correction function helps ensure even the waveform details are reproduced precisely and accurately.

● Fracture Toughness Testing Software



Fracture Toughness Testing

Allows data analysis in compliance with the most up-to-date fracture toughness test standards. It supports crack propagation testing, KIC/CTOD testing, and JIC testing.

ASTM E647-13, ISO 12108:2012

Crack Propagation Testing

This is for evaluating the crack propagation behavior of notched samples. It is also ideal for introducing preliminary cracks for KIC and JIC testing.

ASTM E399-12, ISO 12737-96
BS 7448-1:1991, ASTM E1820-11

KIC/CTOD Testing

This is for evaluating fracture toughness values. It calculates CTOD values corresponding to the fracture mode and determines the validity of KIC values.

ASTM E1820-11, ASTM E813-89
JIS Z 2284-98

JIC Testing

This is for evaluating elastic fracture toughness values (JIC). It makes it easy to perform JIC tests, which involve complicated procedures.

Amplitude Characteristics

Amplitude characteristic curves are logarithmic graphs that indicate the testing capacity of systems, with frequency plotted on the horizontal axis and the half-amplitude plotted on the vertical axis. Characteristics of the Servopulser series dynamic and fatigue testing systems are determined by the actuator, hydraulic power supply unit capacity, and the servo valve flow rate rating and frequency characteristics. Select the optimal system by checking the amplitude characteristics to see that they are consistent with the corresponding test conditions. Tests can also be performed at frequencies below 0.1 Hz; these are not shown here.

- The amplitude characteristic curves in this product brochure indicate the relation between half-amplitude and cycle speed, given sine wave motion at the rated load level.
- The lower left area of each characteristic curve indicates the testing capacity range, which depends on the capacity and stroke length of the selected actuator and the capacity of the hydraulic power supply unit.
The curve below indicates the amplitude characteristics given a 60 Hz power supply. Characteristics with a 50 Hz power supply will be about 5/6 of indicated values.
- The amplitude characteristics indicated in this brochure do not include the frame or load cell characteristics. Compensate for the influence of these factors to determine actual amplitude characteristics.
- The amplitude characteristics indicated in this brochure were calculated based on typical characteristics of the servo valve being used, which may result in a difference of about 10 % on the frequency axis.
- There may be limitations on testing frequencies, due to the jig, sample, or other characteristics.

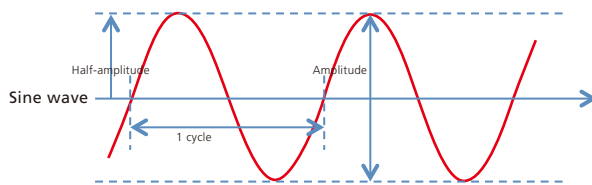

● To Perform Tests at a Frequency of 10 Hz

Starting at 10 Hz on the horizontal axis, move your finger upward parallel to the vertical axis until it intersects the amplitude characteristics curve. Then move it left parallel to the horizontal axis until it intersects the vertical axis. The value at that intersection point indicates the half-amplitude testing capacity at 10 Hz. In other words, it indicates that at 10 Hz the system is capable of applying a maximum amplitude of ± 6 mm.

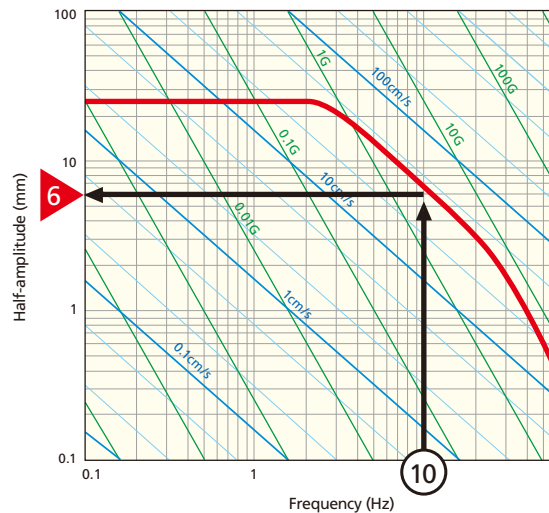

Frequency vs. Testing Time

This table indicates the time required to perform 10^7 test cycles at the given frequency.

Fatigue tests involve a huge number of cycles. Therefore, performing tests at high frequencies can significantly reduce the overall testing time.

Test frequency	Cycles	Testing time
1Hz	10^7 cycles	116 days
3Hz	10^7 cycles	29 days
5Hz	10^7 cycles	23 days
10Hz	10^7 cycles	12 days
30Hz	10^7 cycles	3.9 days
50Hz	10^7 cycles	2.3 days
100Hz	10^7 cycles	1.2 days
300Hz	10^7 cycles	9 hours
20kHz	10^7 cycles	8 minutes



Shimadzu Corporation

www.shimadzu.com/an/

Company names, product/service names and logos used in this publication are trademarks and trade names of Shimadzu Corporation or its affiliates, whether or not they are used with trademark symbol "TM" or "®".
Third-party trademarks and trade names may be used in this publication to refer to either the entities or their products/services. Shimadzu disclaims any proprietary interest in trademarks and trade names other than its own.

For Research Use Only. Not for use in diagnostic procedures.
The contents of this publication are provided to you "as is" without warranty of any kind, and are subject to change without notice. Shimadzu does not assume any responsibility or liability for any damage, whether direct or indirect, relating to the use of this publication.

© Shimadzu Corporation, 2015

Printed in Japan 3655-02507-30AIK